

S E R I E S 1200

FOAM DOCK SEAL With Adjustable Head Pad

The Series 1200 Dock Seal saves energy dollars while providing airtight protection to the loading dock area during material handling operations. The Series 1200 effectively services varying height vehicles at a wide range of door heights.

Our superior adjustable head pad design provides for easy positioning, while the continuous follower curtain seals above the head pad throughout its full travel.

The vehicle positioned at the dock compresses the resilient foam side pads, eliminating the gap between the facility and the vehicle body. This separation of interior and exterior environments allows for a safe loading dock area while ensuring employee comfort and efficiency.

The airtight barrier that Fairborn dock seals provide regulates the facility's atmosphere to be free from air-borne contaminants, insects, and foul weather; while enhancing building security.

To ensure maximum durability, the Series 1200 is available in our superior performance materials. Fairborn created the first certified performance fabrics designed solely for the construction of dock seals and shelters. Our exclusive materials meet or exceed the most demanding requirements and have proven to out-perform any fabric in today's dock shelter market.

Fairborn[®]

FAIRBORN USA INC.



FOAM DOCK SEAL

SERIES 1200

“Fairborn is dedicated to producing the highest quality product in appearance and structural integrity.”

The pride in workmanship of our experienced personnel, combined with the utilization of the finest grade raw materials, assures products of the highest caliber.”



Quality features and components that ensure our customers the best product value...

- 1 Cover Fabric**
Fairborn offers fabrics in a wide range of colors and performance levels. A valued consideration is Dynalon, one of our superior performance materials. Dynalon's extraordinary life expectancy is attributed in part to its excellent tear and abrasion resistance properties.
- 2 Foam**
Fairborn developed a polyurethane foam to properly compress, while conforming to the irregularities of the vehicle body. Superior recovery characteristics ensure the foam's return to its original shape and size.
- 3 Frame**
The Series 1200 incorporates a reinforced steel channel head frame. The side frames are select dimensional lumber of the highest grade, pressure treated and kiln dried before and after treating. (Formed steel sides are optional.)
- 4 Chemical Weld**
The foam is chemically bonded to the entire contact area of the frame to ensure maximum structural integrity.
- 5 Air Exhaust**
Each pad is equipped with properly sized outlets to allow for free air escape during compression while prohibiting moisture infiltration.
- 6 Guide Stripe**
Each side pad includes highly visible yellow stripes to facilitate accurate truck positioning. Fairborn developed a superior "Urethane Finish" to ensure greater stripe durability while maintaining a clean appearance.
- 7 Thread**
All stitching is performed by professional seamstresses utilizing bonded, high tensile, multi-cord polyester thread. The sewn construction provides for lockstitch, proper tension, and backtack sewing techniques throughout.
- 8 Follower Curtain**
The full unit width fabric curtain provides a uniform, continuous tension allowing for even positioning of the head pad. This taut curtain completes the seal above the head pad.
- 9 Hood**
Each unit includes a formed, galvanized metal hood to protect the counter-balance assembly from the elements, while perfecting the overhead seal.
- 10 Counterweight**
The adjustable head pad's effortless movement is the result of the accurately balanced weight system.

Head Pad Standard Features...

- ① **The Curtain Shaft**
converts the counterweight's vertical force to a rotational movement, providing for an even and taut feed of the follower curtain.
- ② **Sealed Bearings**
ensure maintenance free, effortless rotation of the curtain shaft.
- ③ **The Cable Drum's**
precisely forged grooves ensure uniform lead of the stainless steel cable.
- ④ **Guide Pins**
machined from heavy steel bars are welded within the head frame to guarantee positive travel.
- ⑤ **Track Assemblies**
are incorporated into each side pad to provide parallel structural guides for the Guide Pins.

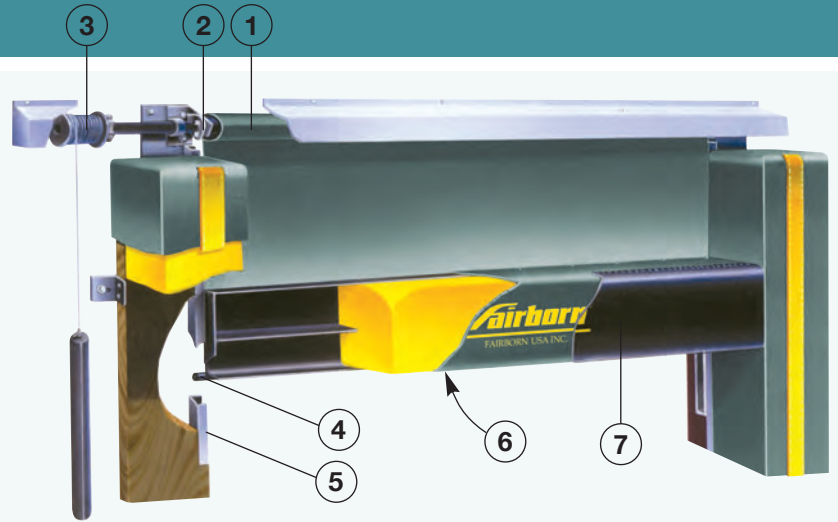

Head Pad Options...

- ⑥ **Underside Reinforcement**
reduces the potential for damage caused by contact from a high load.
- ⑦ **Reinforced Wear Face**
increases the durability of the entire contact area.

Optional Side Pad Fabric Construction...

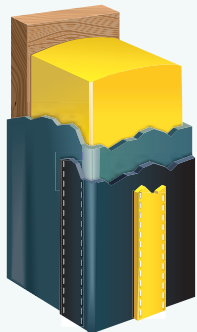

Reinforced Face

This option further reinforces the entire contact surface of the side pad for greater durability.

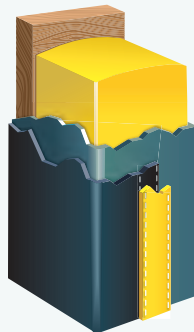

Reinforced Inside

Reinforcing the portion of the side pad that is exposed to the door opening, reduces the potential for damage caused by contact from a wide load.

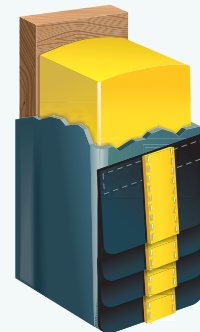

Dyna-Armor Pleats

A pleat construction the full length of the side pad provides for maximum protection. This option is available in 4", 8" or 16" exposure.

A few of the many Series 1200 design options to tailor suit your requirements...

The **Travel Range Availability** of the Adjustable Head Pad allows for the accommodation of the widest range of vehicle and door height variations.

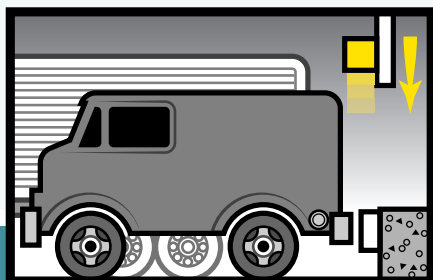

Beveled Side Pads allow standard vehicle widths to be serviced at wider openings. The bevel profile provides for a "wiper" action, allowing for greater accessibility to the rear of the vehicle, while reducing pressure onto the facility wall.

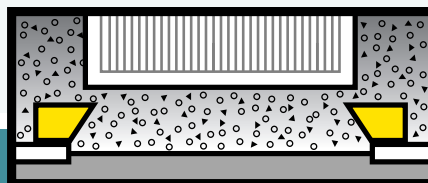

Tapered Units provide a uniform seal when accommodating an inclined or declined drive approach. This option reduces the potential of overcompression.

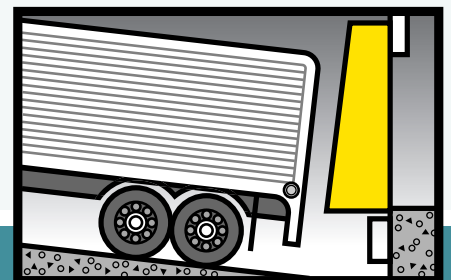



During the last two decades, Fairborn has earned an unmatched reputation for excellence.

Highest Quality

Fairborn is dedicated to the efficient production of the highest caliber products. This commitment provides for product life expectancy far beyond any competitive model and ensures our customers maximum value. Years of design, research and development have provided Fairborn with the most complete and reliable line of products.

Leader In Innovation

Fairborn created the first certified, superior performance fabric designed solely for the construction of dock seals and shelters. Our field proven Dynalon has been widely accepted by industry, and continues to lead with many specifying agencies and quality minded customers throughout the world.

Finest Service

Fairborn's commitment to service is supported by a qualified nationwide representative network, and our experienced sales, engineering and management staff. This expertise ensures our success in providing Fairborn customers the best tailor fit product for their specific needs.

Please contact your local Fairborn representative to enable us to design a unit that will enhance the aesthetic value of your facility, while saving you costly energy dollars. If you have any comments, suggestions or questions regarding our many products or services, we'd like to hear from you.

Fairborn[®]
