

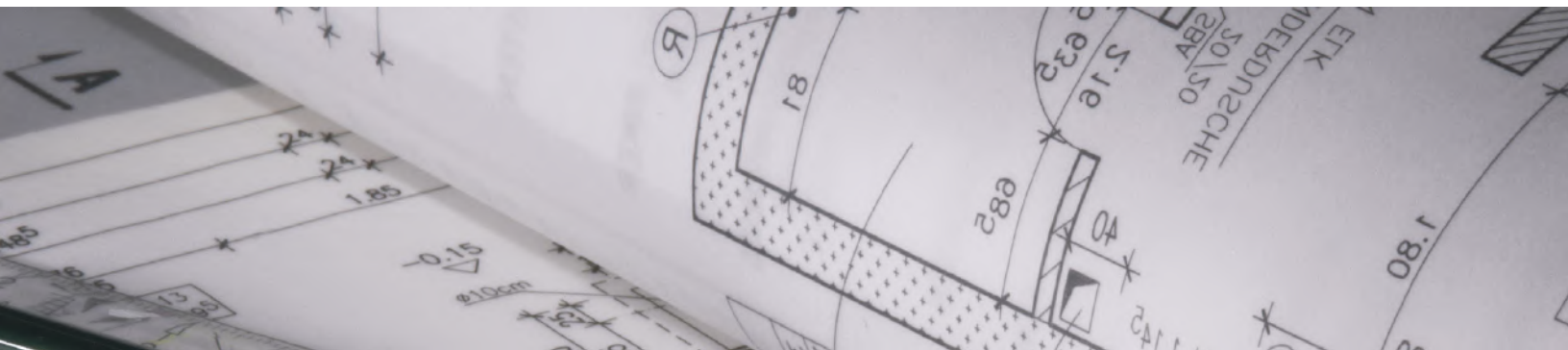

Air Powered Loading Dock Levelers



With over 30 years of experience manufacturing quality loading dock equipment, Pentalift is your single-source supplier for loading dock levelers, dock lifts, dock seals & shelters, vehicle restraints, and much more.



Engineered for Safety

Pentalift Series AD Air Powered Dock Leveler

The Pentalift series AD air powered dock leveler fits between the hydraulic and mechanical dock leveler product range. Featuring fewer moving parts than a mechanical dock leveler an air powered dock leveler will reduce maintenance requirements. Air powered dock levelers offer many beneficial operational and safety features. These features are shown on the following pages.

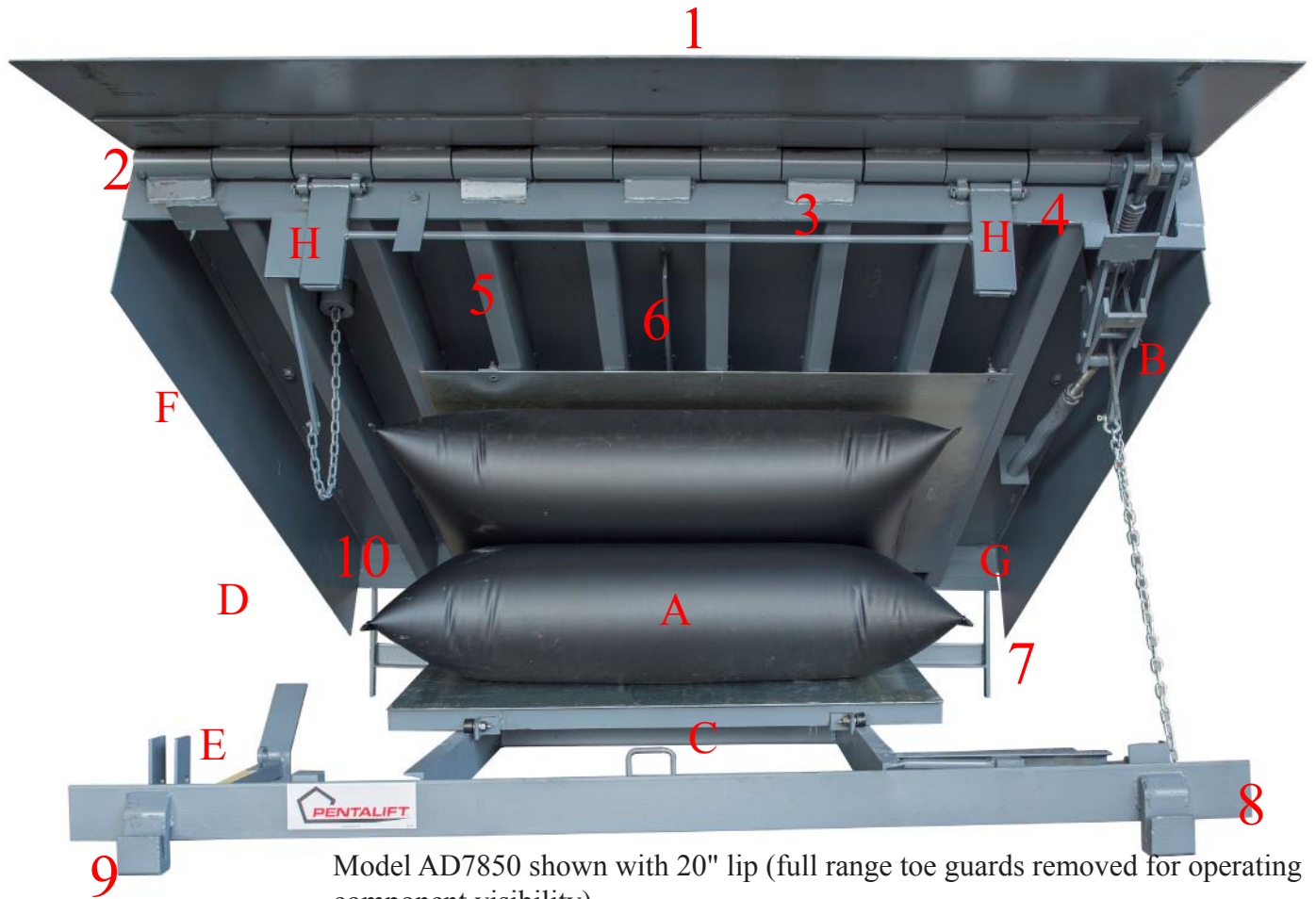

Model AD7850 shown with 20" lip (full range toe guards removed for operating component visibility).

Series AD Air Powered Dock Leveler Structural Features

- 1 High-strength, 4-way safety tread plate, deck and lip assembly: 55,000 psi yield.
- 2 Full-width self cleaning, heavy-wall hinge tube: 70,000 psi yield.
- 3 Gussets on lip and headboard hinge maximize support.
- 4 3/8" Thick, 50,000 psi yield, headboard with bridged gaps.
- 5 Structural, precision-formed "C" beams; 65,000 psi yield. Specially designed beams allow Pentalift to create and build the deck support with optimal strength-to-weight ratio for a dock leveler. Utilizing 10 beams assures an even load distribution and maximum deck support.
- 6 Central deck beam provides added support for three wheeled vehicles.
- 7 Rear frame assembly features four vertical structural members with six points of even support for the full width of the rear hinge.
- 8 Heavy-duty front frame provides full width, cross traffic support and superior building aesthetics.
- 9 Night locks prevent unauthorized entry when overhead door is locked on top of dock leveler.
- 10 Full width, structural channel tail board and one piece, full width rear hinge, complete with heavy steel gussets. Pentalift's unique, welded assembly provides a box section for superior support and strength.

Pentalift Series AD, Air Powered Dock Leveler Operating Features

Pentalift air powered dock levelers incorporate unique and important operating features to achieve safe and reliable operation. These operating features are described in more detail below. Refer to the photograph on page 2 for the letter association.

A Air Bag

The Pentalift air bag is constructed from reinforced coated polyester fibers. The bag is resistant to most chemicals, scrapes and punctures. The bag design functions on high volume low pressure. The air bag material has an extremely wide temperature operating range. It is suitable for extremely cold as well as hot applications. During product testing the bag withstood substantial overload pressure.



B Lip Operator



The patented Pentalift lip operator mechanism yields in the event of an impact from an approaching truck. It comes with an adjustable spring to offset the effective weight of the dock leveler lip. The design has been proven for over 15 years on Pentalift mechanical dock levelers.

C Air Bag Tray Assembly

The air bag tray assembly uses structural components to transmit the air bag forces. The rollers are high precision cam followers. The rollers run on the top of the 4" deep frame beams keeping them away from dirt and debris generally found on the floor of the pit. These beams provide a smooth and hard tracking surface for improved lifting efficiency. The air bag contact surfaces (upper and lower) are galvanized steel to resist corrosion.



D Blower Assembly

The 115 volt blower assembly is installed at the rear of the dock leveler. The blower is a self cleaning design. It is provided in a metal housing and with an easy to remove and clean filter assembly. The low current requirements negate the need for dedicated electrical supply to the loading dock.

Pentalift Series AD, Air Powered Dock Leveler Operating Features (continued)

E Integral Maintenance Stand

An integral maintenance stand facilitates support during routine inspections and maintenance. The maintenance stand supports the lip as well the dock leveler deck assembly.

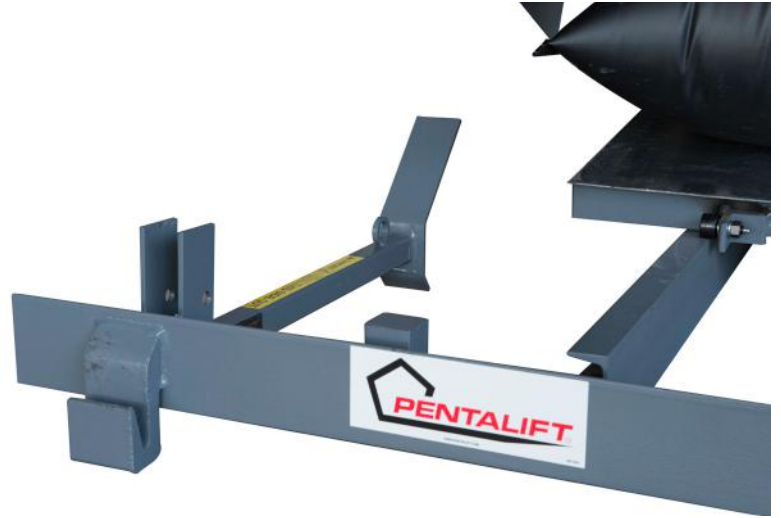

F Full Range Toe Protection

Full range toe protection; telescopic metal toe guards provide protection throughout the entire operating range of the dock leveler.

Note: The full range toe guards are removed on many of the photos in this brochure to facilitate operating component visibility.



G Fixed Rear Hinge

Fixed rear hinge remains flush with the rear of the pit to eliminate pinch points and surface obstructions. The small gap at the deck plate and frame conjunction reduces impact or bump for fork lift operators compared to competitive designs.

H Mechanical Fall Safe Legs (optional)

Mechanical fallsafe legs are available as an option to meet project specifications that require them.

Pentalift Air Powered Dock Leveler Control Panels

Pentalift adds value by designing and assembling its own control panels "in house" to accommodate the interlocking of other dock equipment such as vehicle restraints, overhead doors and inflatable dock seals/shelters to create a safe and productive loading dock system. Please contact your Pentalift representative for options available for your application.

Simple Basic Operation

- NEMA 12 – wall mounted push button station, facilitates simple basic operation.
- Protects against falling dirt, circulating dust, lint, fibers, filings and dripping or light splashing of liquids.
- Other NEMA rated enclosures are available.
- An instructional wall mounted placard is provided as standard.

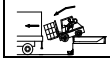
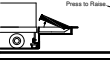
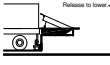
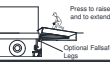

PENTALIFT		OPERATING INSTRUCTIONS FOR AIRBAG DOCK LEVELER W/1-BUTTON CONTROL	
 <p>• Read and follow all instructions, warnings and maintenance schedules in the owner's manual and all placards.</p> <p>• Restrict use or service of dock leveler to properly trained personnel.</p>	<p>Normal operation</p> <p>1) Press the raise button on the control panel to raise leveler.</p>	 <p>Press to raise</p>	<p>2) Continue to press the button. The lip will automatically extend as the leveler deck is fully raised.</p>
<p>• Always check trailer wheels or engage trailer restraint and set parking brakes and dump air before operating dock leveler or beginning to load/unload.</p> <p>• Before actuating dock leveler, ensure lip avoids contact with trailer sides and cargo. If lip does not lower to trailer bed, reposition trailer.</p> <p>• Ensure that the truck bed sufficiently supports the extended lip or the leveler frame properly supports the deck before driving on deck.</p> <p>• Stay clear of hinges and front and sides of moving dock leveler.</p> <p>• Never use hands or equipment to move the deck or lip.</p> <p>• Never use damaged or malfunctioning dock leveler. Report problem immediately to supervisor.</p> <p>• Always store dock leveler and remove people, material, and equipment from deck before vehicle leaves the dock.</p> <p>• DO NOT ENTER PIT under dock leveler is securely supported by maintenance stand. (Refer to owner's manual)</p> <p>• Disconnect power and properly tag or lock out dock leveler before entering the dock leveler pit or doing any repair or inspection under the dock leveler.</p> <p>• Barricade all areas from traffic around the work area inside (and outside if applicable) for safety and post appropriate warning signs.</p> <p>DANGER! Failure to follow these instructions could result in death or serious injury.</p>	<p>3) When dock leveler deck is fully raised and the lip is fully extended release the button. The leveler will float down to the truck bed. If necessary release the optional full safe legs to allow the dock leveler to float below level. Commence loading/unloading. Warning: Return the leveler to the dock level storage position for end loading. (See owner's manual for more details)</p> <p>Warning: Never drive onto the dock leveler unless it is supported by the truck bed or by the below level steps. Damage to the air bag could result. Warning: Never continue to press the button after the dock leveler lip is fully extended.</p>	 <p>Press to lower</p>	<p>4) Starting leveler after loading/unloading complete</p> <p>1) To return the leveler to stored position, press the button. As the leveler raises the lip will retract. When the lip is fully retracted and above the lip keepers, release the button. The leveler will float down to the stored position. Caution lip is properly positioned behind lip keepers. (See owner's manual for more details)</p>
<p>• Disconnect power and properly tag or lock out dock leveler before entering the dock leveler pit or doing any repair or inspection under the dock leveler.</p> <p>• Barricade all areas from traffic around the work area inside (and outside if applicable) for safety and post appropriate warning signs.</p> <p>DANGER! Failure to follow these instructions could result in death or serious injury.</p>	<p>2) Press the button and leveler is fully raised and the lip just starts to extend. Release the button and walk onto the dock leveler to pull the below level release ring (located at the front of the dock leveler) the lip will extend to clear the lip keepers as the dock leveler lowers to the below level steps. (See owner's manual for more details)</p>	 <p>Press to raise and to extend lip</p> <p>Optional Full Safe Legs</p>	<p>Before dock end loading</p>
<p>PENTALIFT Telephone: 519 763-3625 Fax: 519 763-2894 Call number above for additional safety labels, or manuals, or with questions regarding proper use, maintenance, and repair of dock leveler</p>		<p>NOTE: FOR UNITS EQUIPPED WITH AUTO RETURN AND/OR DECK STOP AND UNITS WITH A</p>	



Master Control Panels

- Proven long term technology eliminates replacing costly touch pad circuit boards. Hard wired components are more robust than circuit board designs. This is important in loading dock environments in which dramatic temperature change typically take place. Hard wired components are easier for the average electrician to trouble shoot and result in lower maintenance costs. Operator confusion or error is addressed by providing a single interlocked and synchronized panel to operate all equipment at the loading dock. Master control panels provide a productive and safe operating dock system and the single panel significantly reduces electrical hook-up costs.

Other Control Panel Options:

- Lockable electrical disconnects
- Overhead door controls
- GFCI duplex outlets for dock light
- Other NEMA rated enclosures
- For special requests consult factory

Pentalift Air Powered Dock Leveler Options

Pour In Place



This option simplifies installation and reduces costs in new construction applications. A metal frame and pan encloses the dock leveler. This allows the dock leveler to be placed into a recess in the foundation and to have concrete poured around it during the floor pour of the building. Installation welding is completed at the factory. Overall costs of installing the dock leveler are reduced substantially.

Weatherseal



This option provides a rubber or brush weatherseal along the sides and rear of the dock leveler. The weatherseal reduces the passing of outside elements (cold, heat or debris) into the facility by sealing the edges of the dock leveler against the dock leveler pit. In addition, brush weatherseal is effective in reducing the entry of vermin into the facility as well. The weatherseal is provided with metal carriers. As wear results to the seal, replacement seals can be simply slid into the metal carriers.

Steel Face Dock Bumpers



This option provides a very durable dock bumper. The bumper is comprised of laminated bumper sections behind a plate steel bumper face. The laminated rubber sections absorb the impact of the truck and trailer as it backs into the loading dock. The steel facing prevents the trailer from cutting or overly compressing the rubber absorption material as the trailer backs into the loading dock and scrapes up and down on the bumpers as it raises and lowers with the suspension. The combination of the two components makes the steel face dock bumper an excellent solution for harsh loading dock environments.

Other available options for Air Powered Dock levelers

Longer Lip Lengths

Epoxy Paint Finishes

Weatherseal Rubber or Brush (shown above)

Shim Kits (To fit dock leveler to deeper pits)

Upgraded Capacities

Pour In Place Installation (shown above)

Spray Foam Insulation

Easy Sweep Frame

Safety at the Loading Dock

The loading dock has been rated as one of the most hazardous areas of any facility. To increase safety at the loading dock more and more companies are installing a combination of dock levelers and vehicle restraints. When the dock leveler and the vehicle restraint are ordered together at the same time the controls and function can be interlocked.

Pentalift vehicle restraints not only lock the trailer in position, they also provide clear communications between the truck driver and the loading dock attendants.

Pentalift Vehicle Restraint Systems

Pentalift manufactures and offers four styles of vehicle restraints. The variety of designs provided suit almost any loading dock application and create a safe productive loading dock system. All units can be interlocked to the dock leveler for increased safety. Contact a Pentalift sales representative for additional information.



Model RVR32:

A raised, face mounted, off the ground design. The front extension bar provides an operating range of 9" low to 25" high.

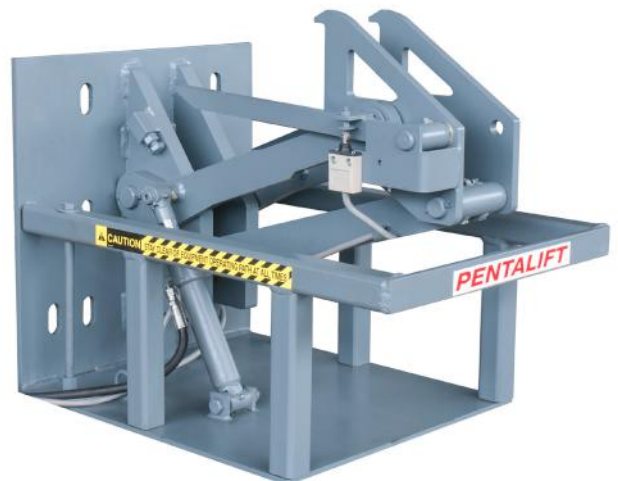

Model HFR32:

Reliable hydraulic operation is controlled by push buttons. Suitable for harsh, busy environments.



Model LPR35:

Provides the same features and benefits of the HFR32. In addition features an extremely low lowered height as well as a stepped hook for dual locking positions.

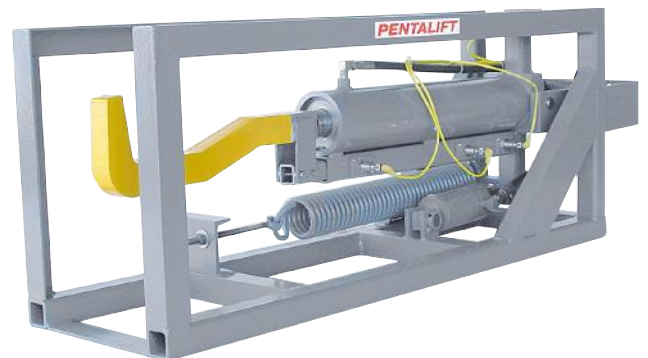

Model UHR40:

Installed under the dock leveler to provide the ultimate in safety, performance and reliability. Suitable for severe and extremely busy environments.

Pentalift also provides a wide variety of equipment to create an efficient, secure, and safe loading dock environment. In addition to the products shown in the photographs below Pentalift also offers the following products; including edge of dock levelers, safety barriers, wheel chocks, dock lights, and dock bumpers, making Pentalift your ideal, single-source, loading dock equipment supplier.

Pentalift Hydraulic Dock Levelers



Pentalift Vehicle Restraints (See page 7)



Pentalift Dock Seals and Shelters



Pentalift Vertical Storing Dock Levelers



Pentalift Dock Lifts



Pentalift Truck Levelers & Dock Seals



"Our Primary Goal is to engineer and build the best products to ensure the ultimate in user safety and product reliability"

*Paul Pedersen
President
Pentalift Equipment Corporation*

Individual Product Catalogs are available and can also be found on our website.
Pentalift also manufactures a complete line of lift tables for your in plant material handling needs.

Note: Some photos may reflect products with optional features. All Pentalift Equipment Corporation products are subject to design improvement through modification without notice.