

SECTIONAL STEEL **DOOR** SYSTEMS



PRODUCT LINE

NON-INSULATED DOORS

INSULATED DOORS

MODELS

416/420/424/430

418/422/426/432



INDUSTRY LEADING
COMMERCIAL & INDUSTRIAL SOLUTIONS



General features and benefits

Solidly constructed for reliable performance

- 16, 20, or 24-gauge steel door panels result in a solidly constructed door for years of dependable service
- Standard steel doors available in sizes up to 32'2" (9804 mm) in width and 24'1" (7341 mm) in height
- Insulated steel doors available in up to 32'2" (9804 mm) in width and 24'1" (7341 mm) in height
- Heavy-duty track and hardware are fabricated of high-quality galvanized steel and engineered for precise, trouble-free performance
- Flexible PVC bottom weatherseal with retainer lessens conductivity of heat and cold, minimizes air and water penetration and accommodates irregular floor conditions
- Option of insulated steel doors provides enhanced thermal efficiency and R-values* of 7.35 (1.29 K m²/W)
- Baked-on, polyester paint finish eliminates field painting and provides long-lasting protection against the elements
- Superior panel strength and well-engineered track design meets wind load requirements and codes

Specialized options for customized solutions

- Full-section or individual-panel glazing satisfies requirements for external light and visitor identification
- Higher-cycle springs in optional 25k, 50k, 75k or 100k-cycles promote long-life in high-usage applications
- Optional steel strutting provides reinforcement for structural integrity on wider doors
- Other options include: electric and chain hoist operation, aluminum sash sections with choice of DSB, acrylic, polycarbonate, tempered, or wire glazing, as well as movable center posts, 3" (76 mm) track, jamb seals
- Impact bottom section available for doors exposed to damage from fork lifts and other warehouse traffic

* R-value is a measure of thermal efficiency. The higher the R-value the greater the insulating properties of the door. Overhead Door Corporation uses a calculated door curtain R-value for our insulated doors.

Cover image: Model 416, Flush panel, White paint finish

Image above: Model 432, Ribbed panel, custom paint finish, Aluminum Sash Section with DSB glazing



Panel options

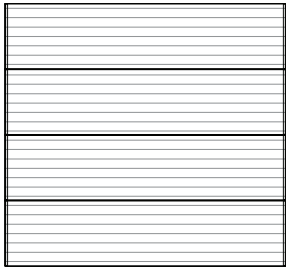

Ribbed panel

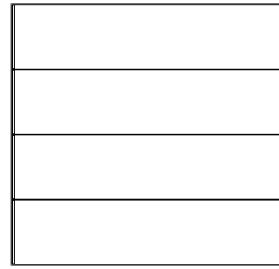

Flush panel

Steel door panel detail

Insulated steel door panel detail

Model 416

Models 420/424/430

Model 418

Models 422/426/432

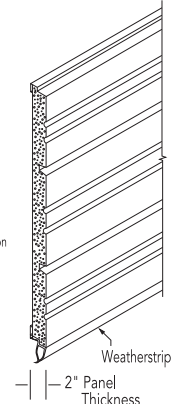
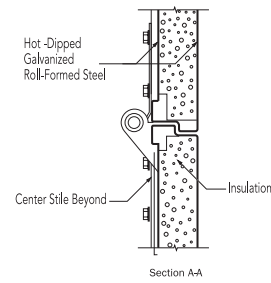
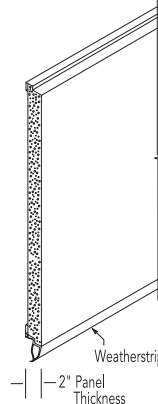
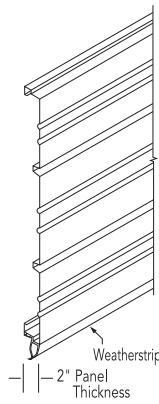
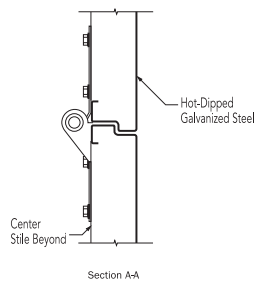
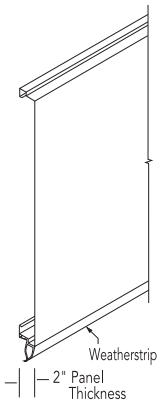

Glazing options

All models:

Available only on 418, 422, 430, 432:



Aluminum Sash Section with DSB glazing



Insulated DSB (24" x 7")

Color options

All models:

Available only on 424, 426, 430, 432:

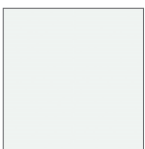

White



Industrial Brown

Actual colors may vary from these shown due to fluctuations in the printing process. Ask your Overhead Door™ Distributor for color samples.



General specifications for SECTIONAL STEEL

	Extra heavy duty	Heavy duty		Medium duty
Model	416	420	424	430
Nominal thickness	2" (51 mm)	2" (51 mm)	2" (51 mm)	2" (51 mm)
Maximum standard width	32'2" (9804 mm)	31'2" (9500 mm)	30'2" (9195 mm)	20'2" (6147 mm)
Maximum standard height	21'1" (6426 mm)	24'1" (7341 mm)	24'1" (7341 mm)	16'1" (4902 mm)
Exterior steel	16-gauge galvanized steel	20-gauge galvanized steel	24-gauge galvanized steel	Nominal 24-gauge galvanized steel
Exterior surface	Flush	Ribbed	Ribbed	Ribbed
Exterior finish color	White baked-on polyester	White baked-on polyester	Industrial Brown and White baked-on polyester	Industrial Brown and White baked-on polyester
End stiles	16-gauge galvanized steel	16-gauge galvanized steel	16-gauge galvanized steel	16-gauge galvanized steel
Intermediate stiles	16-gauge galvanized steel	16-gauge galvanized steel	16-gauge galvanized steel	16-gauge galvanized steel
Lock	Interior-mounted slide lock	Interior-mounted slide lock	Interior-mounted slide lock	Interior-mounted slide lock

Available options for SECTIONAL STEEL

Electric operator	•	•	•	•
Bottom sensing edge	•	•	•	•
Chain hoist	•	•	•	•
Pull-rope auto release	•	•	•	•
Full sash section (glazing options)				
1/8" (3mm) DSB, insulated	•	•	•	•
1/8" (3mm) & 1/4" (6mm) acrylic	•	•	•	•
Individual lites (glazing options)				
1/8" (3mm) DSB	•	•	•	•
1/8" (3mm) & 1/4" (6mm) acrylic	•	•	•	•
1/8" (3mm) & 1/4" (6mm) polycarbonate	•	•	•	•
1/8" (3mm) & 1/4" (6mm) tempered	•	•	•	•
1/8" (3mm) & 1/4" (6mm) wired	•	•	•	•
3" (76 mm) track	•	•	•	•
Higher-cycle springs 25K, 50K, 75K and 100K	•	•	•	•
Exhaust ports	•	•	•	•
Industrial Brown paint finish			•	•
5-pin tumbler keyed lock	•	•	•	•



MODEL 430

Solid construction ideal for small warehouses and service stations.



Panel schedule

Door width	Number of panels
8'2" to 10'2" (2438 mm to 3099 mm)	2
10'3" to 12'2" (3124 mm to 3708 mm)	3
12'3" to 16'2" (3734 mm to 4928 mm)	4
16'3" to 19'2" (4953 mm to 5842 mm)	5
19'3" to 20'2" (5867 mm to 6147 mm)	6

Section schedule

Door height	Number of sections
to 8'1" (2464 mm)	4
8'2" to 10'1" (2489 mm to 3073 mm)	5
10'2" to 12'1" (3099 mm to 3683 mm)	6
12'2" to 14'1" (3708 mm to 4293 mm)	7
14'2" to 16'1" (4318 mm to 4902 mm)	8

Standard features at a glance

Nominal thickness	2" (51 mm)
Maximum standard width	20'2" (6147 mm)
Maximum standard height	16'1" (4902 mm)
Exterior steel	Nominal 24-gauge galvanized steel
Exterior surface	Ribbed
End stiles	16-gauge steel
Center stiles	16-gauge steel
Standard mounting	Angle mount
Standard track	2" (51 mm)
Standard springs	10,000 cycle
Weatherstripping	Standard on bottom
Operation	Manual pull rope
Finish	White baked-on polyester
Lock	Interior-mounted slide lock

Options

Electric operator or chain hoist
Bottom sensing edge
Full sash section with 1/8" (3 mm) DSB; 1/8" (3 mm) insulated; 1/8" (3 mm) and 1/4" (6 mm) acrylic
Individual lites with 1/8" (3 mm) DSB; 1/8" (3 mm) and 1/4" (6 mm) acrylic; 1/8" (3 mm) and 1/4" (6 mm) polycarbonate; 1/8" (3 mm) and 1/4" (6 mm) Tempered; 1/4" (6 mm) wired
Industrial Brown polyester
3" (76 mm) track
Bracket mounting (not available on full vertical)
Higher-cycle springs in 25k, 50k, 75k, 100k cycles
Exhaust ports
Jamb weatherseals
Bottom strips, including looped PVC weatherstrips, flexible PVC astragal weatherstrips and double-contact weatherstrips
Reinforcing struts of roll-formed, galvanized steel
Movable center posts for 2" (51 mm) or 3" (76 mm) tracks that roll away, with automatic safety catches that prevent door closure when posts are removed
Tumbler keyed lock

Track detail

Any of the following track configurations can be selected for sectional steel door models.

O.H.=Opening height L.C.=Lift clearance D.H.=Door height

Standard lift track

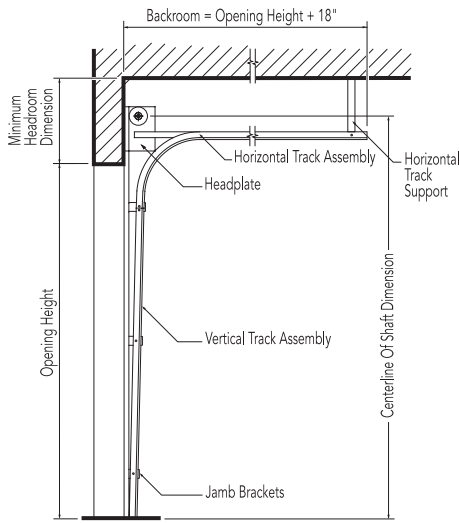

Lift clearance track Standard

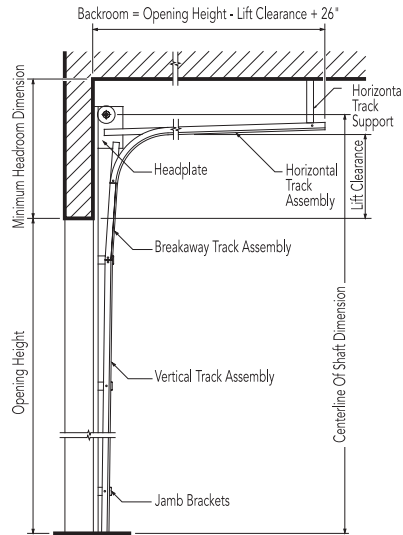

Full vertical track

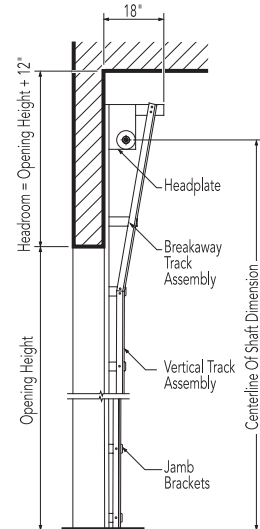

2" (51 mm) Track [15" (381 mm) radius]

Door height	Centerline of shaft	Minimum headroom
Thru 12'0" (3658 mm)	O.H. + 11 5/8" (295 mm)	14 1/4" (362 mm)
Thru 16'0" (4877 mm)	O.H. + 12 5/8" (321 mm)	20 1/2" (521 mm)

2" (51 mm) Track [15" (381 mm) radius]

Door height	Centerline of shaft	Minimum headroom
Thru 12'0" (3658 mm)	O.H. + L.C. + 5 5/8" (143 mm)	L.C. + 8 3/4" (222 mm)
Thru 16'0" (4877 mm)	O.H. + L.C. + 5 5/8" (143 mm)	L.C. + 11 1/4" (286 mm)

2" (51 mm) Track

Door height	Centerline of shaft	Minimum headroom
Thru 11'0" (3353 mm)	O.H. + O.H. + 3/8" (10 mm)	O.H. + 10 1/4" (260 mm)
Thru 16'0" (4877 mm)	O.H. + O.H. + 3/8" (10 mm)	O.H. + 10 1/4" (260 mm)

3" (76 mm) Track [15" (381 mm) radius]

Thru 18'0" (5486 mm)	O.H. + 14 5/8" (372 mm)	18" (457 mm)
Thru 32'0" (9754 mm)	O.H. + 16 7/8" (429 mm)	21 1/2" (546 mm)

3" (76 mm) Track [15" (381 mm) radius]

Thru 22'0" (6706 mm)	O.H. + L.C. + 6 5/8" (168 mm)	L.C. + 11 1/2" (292 mm)
Thru 32'0" (9754 mm)	O.H. + L.C. + 6 5/8" (168 mm)	L.C. + 12 1/4" (311 mm)

3" (76 mm) Track

Thru 18'0" (5486 mm)	O.H. + O.H. + 3/8" (10 mm)	O.H. + 10 1/4" (260 mm)
----------------------	----------------------------	-------------------------

Low headroom track Springs to front

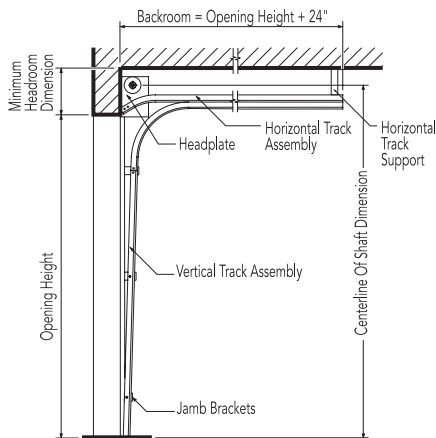

2" (51 mm) Track [15" (381 mm) radius]

Door height	Centerline of shaft	Minimum headroom
Thru 12'0" (3658 mm)	D.H. + 8" (203 mm)	11 3/4" (299 mm)
Thru 16'0" (4877 mm)	D.H. + 8" (203 mm)	12 1/2" (318 mm)

3" (76 mm) Track [15" (381 mm) radius]

Thru 12'0" (3658 mm)	D.H. + 9" (229 mm)	13" (330 mm)
Thru 32'0" (5486 mm)	D.H. + 9" (229 mm)	13 3/4" (349 mm)

Low headroom track Springs to rear

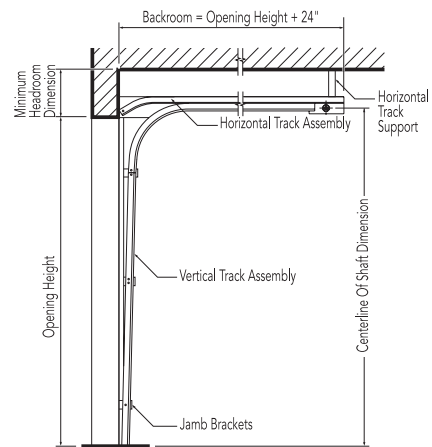

2" (51 mm) Track [15" (381 mm) radius]

Door height	Centerline of shaft	Minimum headroom
Thru 12'0" (3658 mm)	O.H. + 2" (51 mm)	7 1/2" (191 mm)
Thru 16'0" (4866 mm)	O.H. 2" (51 mm)	8" (203 mm)

3" (76 mm) Track [15" (381 mm) radius]

Thru 18'0" (5486 mm)	O.H. 6 3/4" (171 mm)	9 3/4" (248 mm)
----------------------	----------------------	-----------------



Framing and pad detail

Framing and pad details for common installation of Sectional Steel and Insulated Steel Doors in steel, wood, concrete and masonry jambs are provided here. If you require additional information or have special project requirements, refer to the Architectural Design Manual, (www.overheaddoor.com/ADM/base.html) or consult with the Applications Engineering Group or your local Overhead Door™ Distributor.

Steel jambs

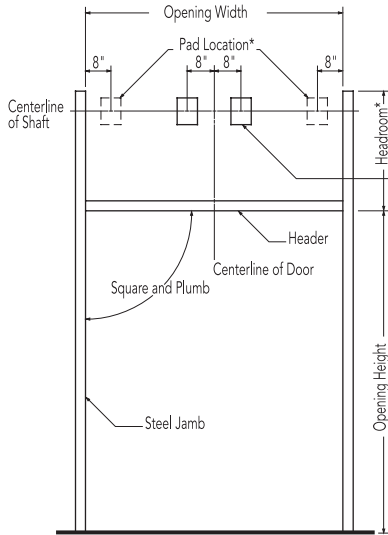

* Pad Location for additional shaft support brackets for doors over 18'3" wide

Wood jambs

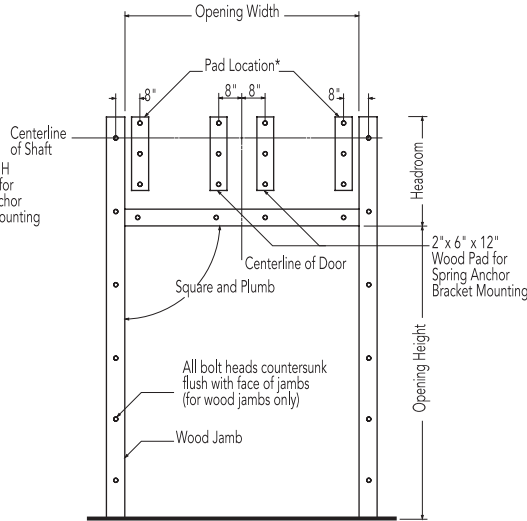

* Pad Location for additional shaft support brackets for doors over 18'3" wide

Concrete/masonry jambs

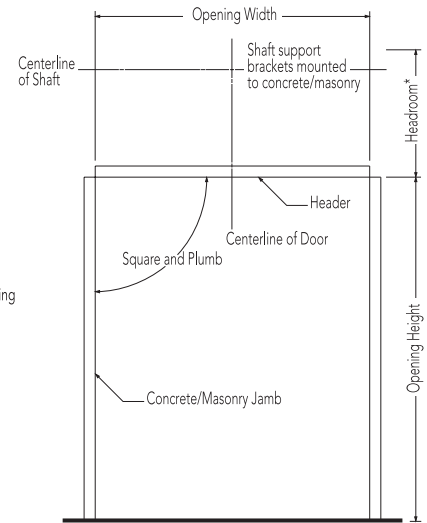

2" (51 mm) track

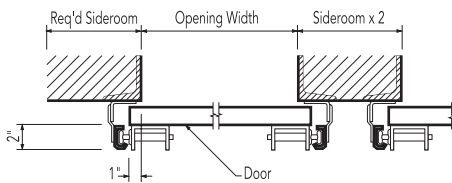

2" (51 mm) track

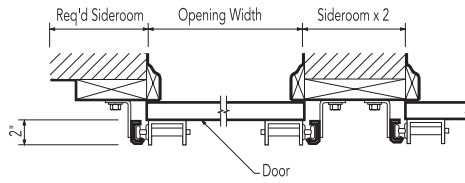

2" (51 mm) track

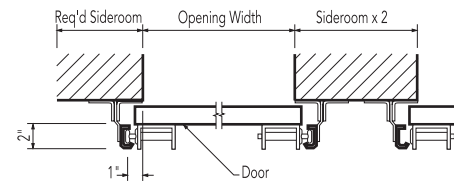

3" (76 mm) track

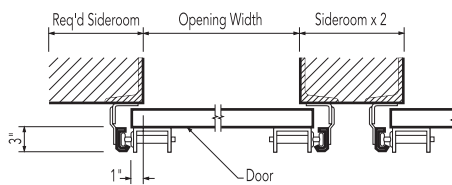

3" (76 mm) track

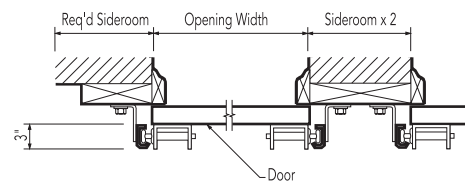

3" (76 mm) track

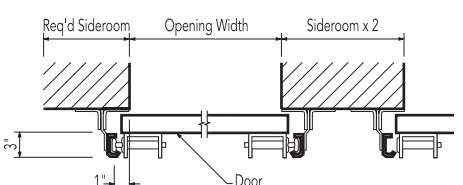

Minimum required sideroom

Track type	2" Track (51 mm)	3" Track (76 mm)
Standard lift	3 1/2" (89 mm)	5 1/2" (140 mm)
Low headroom	8" (203 mm)	9" (229 mm)
Lift clearance	3 1/2" (89 mm)	5 1/2" (140 mm)
Full vertical	3 1/2" (89 mm)	5 1/2" (140 mm)

Minimum required sideroom

Track type	2" Track (51 mm)	3" Track (76 mm)
Standard lift	4 1/2" (114 mm)	6 1/2" (165 mm)
Low headroom	9" (229 mm)	10" (254 mm)
Lift clearance	4 1/2" (114 mm)	6 1/2" (165 mm)
Full vertical	4 1/2" (114 mm)	6 1/2" (165 mm)

Minimum required sideroom

Track type	2" Track (51 mm)	3" Track (76 mm)
Standard lift	4 1/2" (114 mm)	6 1/2" (165 mm)
Low headroom	9" (229 mm)	10" (254 mm)
Lift clearance	4 1/2" (114 mm)	5 1/2" (140 mm)
Full vertical	4 1/2" (114 mm)	5 1/2" (140 mm)

Electric operators

We offer a broad line of electric operators to suit new construction and retrofit applications, as well as unusual or special requirements. In order to improve safety and enhance door and motor life, industry quality assurance guidelines recommend the choice of a single manufacturer for both door and operator applications. We are one of the only national manufacturers to offer a full line of commercial and industrial doors and operators specifically designed for integral applications.

Model RHX®

Model RHX® is a heavy duty commercial operator designed to operate doors up to 24' (7315 mm) in height and 3696 pounds (1676 kg). Available as either a trolley, sidemount or centermount.



Model RSX®

Model RSX® is a standard duty commercial operator designed to operate doors up to 24' (7315 mm) in height and 1620 pounds (735 kg). It offers unique features like LimitLock®, SuperBelt™ and 16 digit menu setup.



Model RMX®

Model RMX® is our most advanced medium-duty operator. It is designed for quicker installation and hassle-free operation and operates doors up to 14' (4267 mm) in height and 620 pounds (282 kg). It is available as a trolley-type or side-mounted unit.



Operator control options

- Push-button, key or combination stations; surface or flush-mounted for interior and/or exterior locations
- Vehicle detectors, photocell and door timer controls
- Treadle or pull switch stations
- Wireless keypad entry and coded keyboard stations
- Universal programmable door timer
- Radio control systems (24 VAC or 120 VAC)
- Explosion and dust ignition-proof systems

Safety recommendations

We strongly recommend the use of interlock switches and monitored safety edge for all electrically operated rolling service doors. If a monitored safety edge or other reversing device is not installed, a constant-contact control switch must be used to close the door. Contact your Overhead Door™ Distributor for more information.

Electric operator selection guide

	Horsepower/ Newtons	Max. height of door	Max. weight of door	Super Belt™/ Polybelt	Worm gear	Adjustable clutch	Totally enclosed	Continuous duty	Explosion proof	Mounting type
RHX®	1/2 HP, 3/4 HP, 1 HP, 3 HP	24' (7315 mm)	3696 lbs (1676 kg)		•	•		•	•	T, S, C
RSX®	1/2 HP, 3/4 HP, 1 HP	24' (7315 mm)	1620 (735 kg)	•		•	•	•		T, S, C
RMX®	1/2 HP	14' (4267 mm)	620 (281 kg)	•						T, S

Mounting options:
T=Trolley
S=Side mount
C= Center mount



Mounting details

Trolley-type (Drawbar) RMX®, RSX®, RHX®

Trolley-type (Drawbar) operators feature a power unit mounted between, above and to the rear of the horizontal tracks. The drawbar drive provides positive control of the door at all times, making this operator the preferred choice whenever possible. Maximum door width is 20' per drawbar. Door width over 20' requires dual drawbar installation. Available on Models RMX®, RSX® and RHX®.

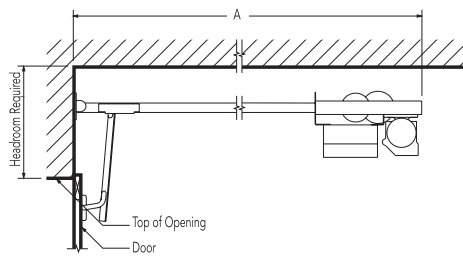

Side mount type (Jackshaft) RMX®, RSX®, RHX®

Side-mounted (Jackshaft) RMX®, RSX®, and RHX® operators feature a power unit mounted on the inside front wall and connected to the crosshead shaft, with an adjustable coupling or drive chain and sprockets.

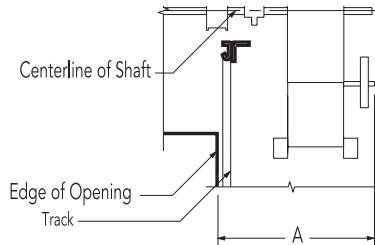

Center mount type/Jackshaft RSX®, RHX®

Center-mounted (Jackshaft) operators feature a power unit on the front wall above the door opening. No additional backroom is required. Available on models RSX® and RHX®.

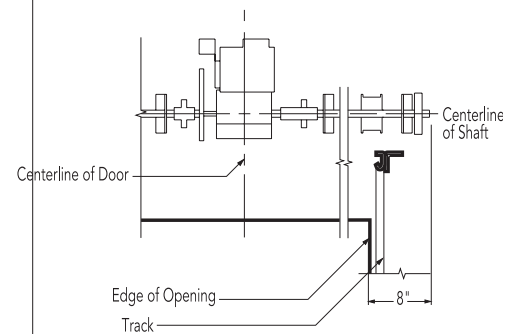

Minimum headroom requirements		"A" dimension - minimum (sideroom)		Minimum headroom requirements	
RMX®	Track requirements +4 1/2" (114 mm)	2" track (51 mm)	3" track (76 mm)	RSX®	Track requirements +14" (356 mm)
RSX®	Track requirements +5" (127 mm)	RMX®	18 1/2" (470 mm) 19 1/2" (495 mm)	RHX®	Track requirements +23 5/8" (600 mm)
RHX®	Track requirements +5" (127 mm)	RSX®	21" (533 mm) 22" (559 mm)		
		RHX®	21" (533 mm) 22" (559 mm)		
Depth requirements - "A" dimension (backroom)					
RMX®	Door height +4' 0" (1219 mm)				
RSX®	Door height +4' 0" (1219 mm)				
RHX®	Door height +4' 10" (1473 mm)				